

5-964492-5 ✓ ACTIVE

[RAST | RAST 5 IDC Connectors](#)

TE Internal #: 5-964492-5

Crimp Terminal Housings, Tab, Tab Housing, 5 Position, Straight, UL 94V-2, Natural, Polyamide, Contact Mating Retention, RAST 5 IDC Connectors

[View on TE.com >](#)



Terminals & Splices > Terminal Housings, Insulation Sleeves & Blocks > Crimp Terminal Housings

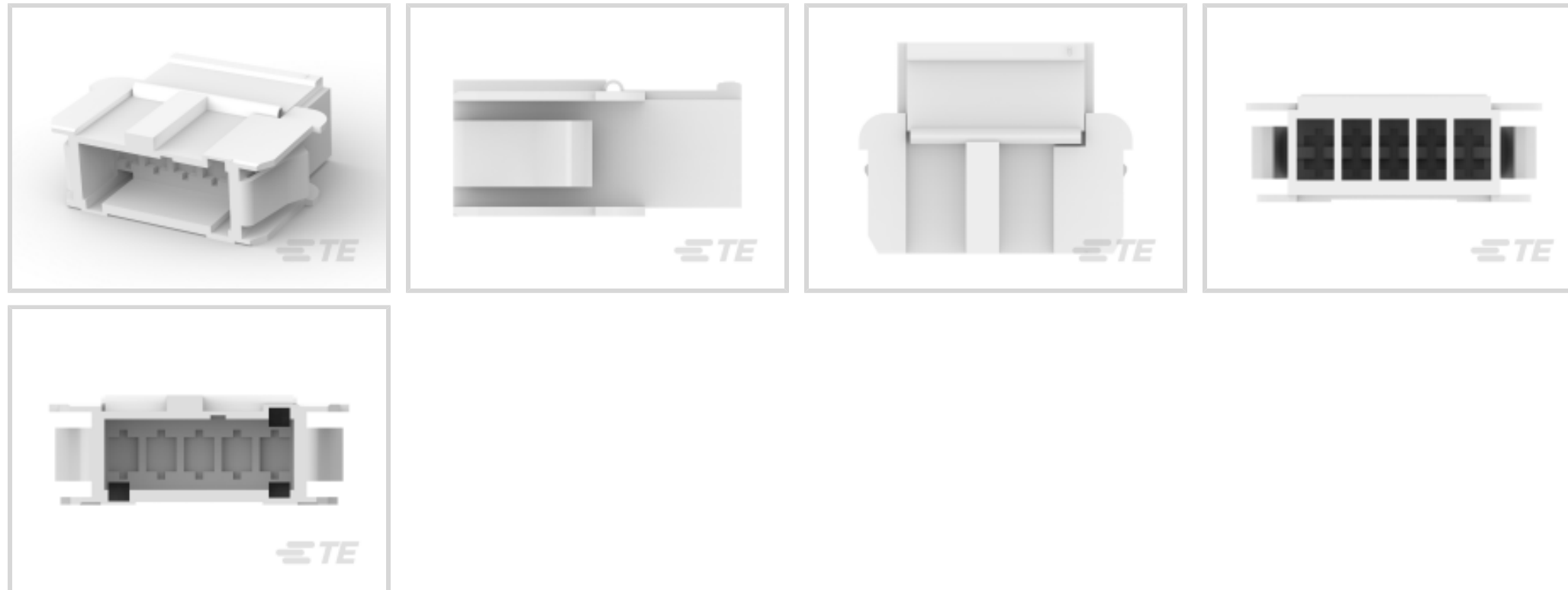

Terminal Type: **Tab**

Housing Type: **Tab Housing**

Number of Positions: **5**

Terminal Orientation: **Straight**

UL Flammability Rating: **UL 94V-2**

Features

Product Type Features

Product Type	Terminal Housing
Style Code	C
Sealable	No
Housing Type	Tab Housing
Insulated	No

Configuration Features

Number of Positions	5
---------------------	---

Body Features

Primary Product Color	Natural
-----------------------	---------

Contact Features

Terminal Type	Tab
Terminal Orientation	Straight
Contact Mating Retention	With



Mechanical Attachment

Mating Alignment Type	Polarization
Mating Retention Type	Locking Lance
Mating Alignment	With
Crimp Terminal Housing Mounting Style	Panel Mount

Housing Features

Housing Material	Polyamide
Centerline (Pitch)	5 mm[.196 in]

Dimensions

Length	30.5 mm[1.2 in]
--------	-----------------

Usage Conditions

Operating Temperature Range	-40 – 105 °C[-40 – 221 °F]
-----------------------------	----------------------------

Industry Standards

UL Flammability Rating	UL 94V-2
------------------------	----------

Packaging Features

Packaging Quantity	1000
--------------------	------

Product Compliance

[For compliance documentation, visit the product page on TE.com>](#)

EU RoHS Directive 2011/65/EU	Compliant
EU ELV Directive 2000/53/EC	Compliant
China RoHS 2 Directive MIIT Order No 32, 2016	No Restricted Materials Above Threshold
EU REACH Regulation (EC) No. 1907/2006	Current ECHA Candidate List: JUNE 2022 (224) Candidate List Declared Against: JUNE 2022 (224) Does not contain REACH SVHC
Halogen Content	Not Low Halogen - contains Br or Cl > 900 ppm.
Solder Process Capability	Not applicable for solder process capability

Product Compliance Disclaimer

This information is provided based on reasonable inquiry of our suppliers and represents our current actual knowledge based on the information they provided. This information is subject to change. The part numbers that TE has identified as EU RoHS compliant have a maximum concentration of 0.1% by weight in homogenous materials for lead, hexavalent chromium, mercury, PBB, PBDE, DBP, BBP, DEHP, DIBP, and 0.01% for cadmium, or qualify for an exemption to these limits as defined in the Annexes of Directive 2011/65/EU (RoHS2). Finished electrical and electronic equipment products

will be CE marked as required by Directive 2011/65/EU. Components may not be CE marked. Additionally, the part numbers that TE has identified as EU ELV compliant have a maximum concentration of 0.1% by weight in homogenous materials for lead, hexavalent chromium, and mercury, and 0.01% for cadmium, or qualify for an exemption to these limits as defined in the Annexes of Directive 2000/53/EC (ELV). Regarding the REACH Regulation, the information TE provides on SVHC in articles for this part number is based on the latest European Chemicals Agency (ECHA) 'Guidance on requirements for substances in articles' posted at this URL: <https://echa.europa.eu/guidance-documents/guidance-on-reach>

Compatible Parts

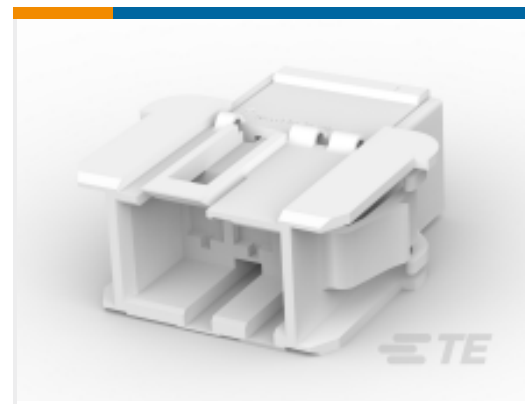

TE Part # 9-927742-3
FASTIN FASTON HOUSING 3POS



TE Part # 1241857-5
5 POS FASTIN/ON HOUSING PANEL MOUNT



TE Part # 927742-6
6 POS FASTIN/ON HOUSING PANEL MOUNT

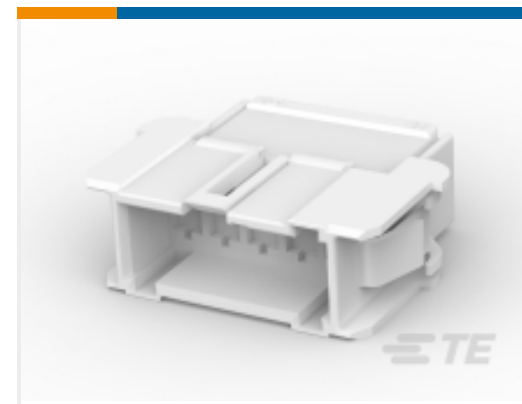

TE Part # 293011-1
5 POS. FASTIN-FASTON CONN. TAB HOUSING R

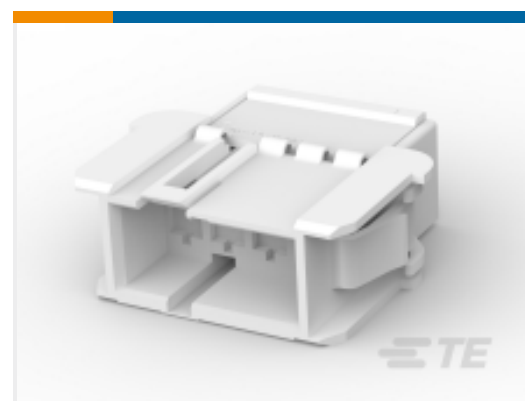

TE Part # 9-927742-4
4POS FASTIN FASTON HOUSING



TE Part # 7-927742-6
6 POS. FASTIN-FASTON* TAB HSG RAST5



TE Part # 927742-4
4 POS FASTIN/ON HOUSING PANEL MOUNT



TE Part # 1241969-8
FASTIN FASTON HOUSING 8P



TE Part # 2-927742-3
3P FF FLACHSTGH6,3



TE Part # 2-927742-7
NO DESCRIPTION



TE Part # 293161-1
5 POS. FASTIN-FASTON* TAB HSG, RAST5



TE Part # 5-927742-3
3P FF FLACHSTGH6,3



TE Part # 9-1241857-5
5POS. FASTIN-FASTON* TAB HSG, RAST5

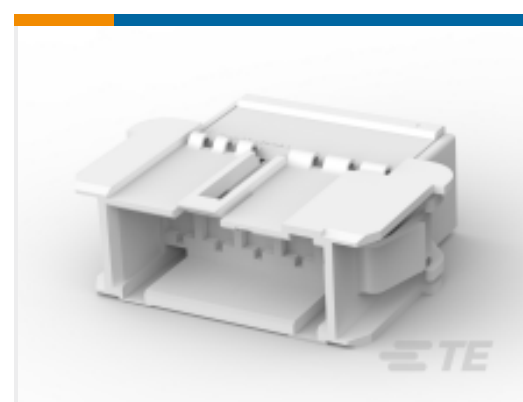

TE Part # 927742-5
5 POS FASTIN/ON HOUSING PANEL

Also in the Series | **RAST 5 IDC Connectors**



Automotive Terminals(8)



Connector Contacts(12)



Crimp Terminal Housings(41)



Insertion & Extraction Tools(1)

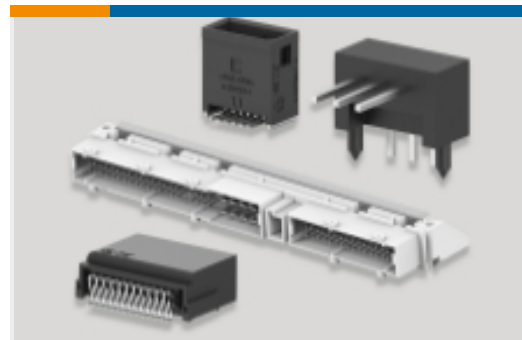

PCB Headers & Receptacles(424)



Rectangular Connector Housings(1)

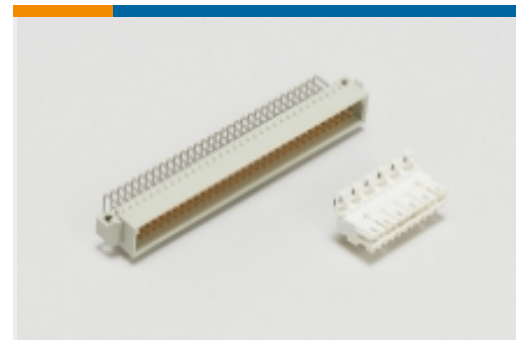

Standard Edge Connectors(47)



Standard Rectangular Connectors(112)

Wire-to-Board Connector Assemblies
& Housings(213)

Wire-to-Board Connector Contacts(2)

Documents

Product Drawings

FASTIN FASTON HOUSING 5POS

English

CAD Files

3D PDF

3D

Customer View Model

[ENG_CVM_CVM_5-964492-5_A.2d_dxf.zip](#)

English

Customer View Model

[ENG_CVM_CVM_5-964492-5_A.3d_igs.zip](#)

English

Customer View Model

[ENG_CVM_CVM_5-964492-5_A.3d_stp.zip](#)

English

3D PDF

English



Customer View Model

[ENG_CVM_5-964492-5_A2.3d_igs.zip](#)

English

Customer View Model

[ENG_CVM_5-964492-5_A2.3d_stp.zip](#)

English

Customer View Model

[ENG_CVM_5-964492-5_A2.2d_dxf.zip](#)

English

By downloading the CAD file I accept and agree to the [Terms and Conditions](#) of use.

Datasheets & Catalog Pages

[FASTIN_FASTON_Product_Line](#)

English

Agency Approvals

[UL Report](#)

English